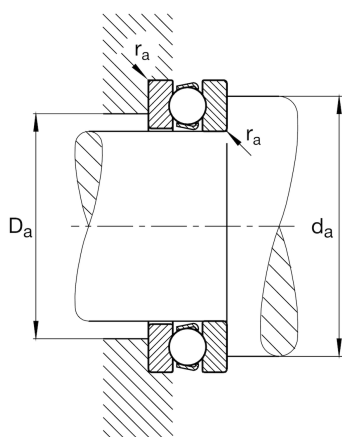
**FAG****51102**

Axial deep groove ball bearing

Schaeffler ID:
0167146440000Axial deep groove ball bearing 511, single
direction, steel sheet metal cage

Technical information

**Main Dimensions & Performance Data**

d	15 mm	Bore diameter
D	28 mm	Outside diameter
T	9 mm	Height
C_a	10,500 N	Basic dynamic load rating, axial
C_{0a}	16,800 N	Basic static load rating, axial
C_{ua}	770 N	Fatigue load limit, axial
n_G	13,100 1/min	Limiting speed
n_{gr}	14,000 1/min	Reference speed
	27 g	Weight

Dimensions

r_{min}	0.3 mm	Minimum chamfer dimension
D_1	16 mm	Bore diameter housing washer
d_1	28 mm	Lip diameter shaft washer

Mounting dimensions

$d_{a min}$	23 mm	Minimum diameter shaft shoulder
$D_{a max}$	20 mm	Maximum diameter of housing shoulder
$r_{a max}$	0.3 mm	Maximum recess radius

Additional information

A	0.002	Minimum load factor
---	-------	---------------------

Temperature range

T_{min}	-30 °C	Operating temperature min.
T_{max}	150 °C	Operating temperature max.